

H3 Series Weighing Scale User manual

© EXCELL PRECISION CO., LTD. 2022. All rights reserved worldwide.

The information contained herein is the property of EXCELL PRECISION CO., LTD. and is supplied without liability for errors or omissions. No part may be reproduced or used except as authorized by contract or other written permission. The copyright and the foregoing restriction on reproduction and use extend to all media in which the information may be embodied.



6F, No. 127, Lane 235, Baoqiao Rd., Xindian District,
New Taipei City 23145, Taiwan



pm-all@excell.com.tw



+886-2-8919-1000



<https://www.excell-scale.com>



+886-2-8919-2209



Table of Contents

PREPARING TO USE THE SCALE 2

PRECAUTIONS FOR USE 2

CHAPTER 1 INTRODUCTION 4

 1-1 PRODUCTION INTRODUCTION 4

 1-2 DISPLAY DESCRIPTION 4

 1-3 KEYPAD FUNCTIONS DESCRIPTION 5

 1-4 POWER DESCRIPTION..... 6

 1-5 ERROR MESSAGES 6

CHAPTER 2 GENERAL OPERATION DESCRIPTION 7

 2-1 BACKLIGHT FUNCTION 7

 2-2 WEIGHING MODE 7

 2-2-1 Units Selection (not available in 4 key model) 7

 2-2-2 Zero Function 7

 2-2-3 Tare Function 7

 2-2-4 Net/Gross Function (only available in 4/5 key models) 8

 2-2-5 Check Weighing Mode (4/5 key models need to set through F4) 8

 2-2-6 Totalizing (not available in 4/5 key models) 10

 2-3 COUNTING FUNCTION (NOT AVAILABLE IN 4/5 KEY MODELS) 10

 2-3-1 Sampling 10

 2-3-2 Check Weighing 11

 2-3-3 Totalizing 11

CHAPTER 3 GENERAL FUNCTION SETTING 11

 3-1 F4 CHECK WEIGHING CONFIGURATIONS 12

 3-2 F5 RS-232 OUTPUT SETTING (OPTION) 13

 3-3 F6 EXIT FUNCTION 18

 3-4 F7 INTERNAL VALUE DISPLAY MODE 18

 3-5 F8 WEIGHT HOLD MODE SETTING 18

 3-6 F11 ID CODE SETTING 20

 3-7 F12 PRINT KEY () FUNCTION SETTING 21

 3-8 F14 CUSTOMIZED HEADER SETTING (R N P 6, R N P 7) 22

APPENDIX 1 OPTION CARD DESCRIPTION..... 23

APPENDIX 2 LOAD CELL PIN 25

APPENDIX 3 MODBUS DATA ADDRESS TABLE 25

APPENDIX 4 7-SEGMENT DISPLAY CHARACTERS 26

Check Firmware Version

Turn on scale and hold **ZERO** key during countdown. Display firmware version 02018.
 Turn off scale and turn on scale and hold **TARE** key during countdown. Display maintenance number 13X where X is ranged from 0~9. Turn off and turn on scale to return to weighing mode.

Thank for your purchasing of our EXCELL Weighing Scale. To guide you to use our product correctly, please read this User Manual carefully to extend the life of machine and to avoid error.

Preparing to Use the Scale

1. Locate the scale on a firm level surface free from vibrations for accurate weight readings. Adjust the four leveling feet to centre the leveling bubble on the scale.
2. Avoid hot sunshine directly on the scale or near the exhaust port of ventilating system.
3. Please use a separate power source plug to avoid the disturbance of other electric appliances.
4. There should be no weight on the scale when power is turned on.
5. Commodity should be placed at the centre of platter when being weighed, and its size should not exceed the dimension of the platter.
6. Please warm the scale 15 ~ 20 minutes before using.
7. Please note that when  symbol appears on the screen, the scale needs to be charged.
8. Any suggestion is warmly welcome.

Precautions for Use

1. Please operate or charge the scale in an open area. Do not squeeze the power cord to avoid wire on fire.
2. Please keep scale in a cool and dry place. Do not store under high temperatures.
3. Please keep the scale clean and free from insect infestation.
4. Avoid impacting with other items or overloaded with excessively heavy weights (The load must not exceed the maximum capacity of the scale).
5. If the scale is not going to be used for some time, please clean it and store it in a plastic bag in dry condition. A desiccant sachet may be included to prevent moisture from building up.
6. Operating temperature: $-10^{\circ}\text{C} \sim +40^{\circ}\text{C}$
7. It is recommended to be used indoors and in environments with a height of less than 2000m
8. If the product is used in a manner not specified by the manufacturer, product warranty may be limited.

9. Due to the storage battery adopt the advanced free-maintaining technique, customers need not to replenish electrolyte.

The scale should be recharged every 3 months to prevent failure of the internal rechargeable battery.

1. The battery should be charged for 8~10 hours.
2. The temperature of battery should below 45°C.

Maintaining

1. Please do not discharge with over-current when using the battery. Please charge the battery after discharging current.
2. Please take down the battery when the scale is not used for a long time or break the connection of cathode.
3. Do not short the battery terminals to check whether there is current. Please check whether the connection point is firm to guarantee good connection.
4. The battery should be replaced by specialized person. **No reverse-battery or the product will be damaged.**
 - a) Anode of battery should be connected with Anode of product battery (usually red cable)
 - b) Cathode of battery should be connected with Cathode of product battery (usually brown cable or black cable)
 - c) See the picture following

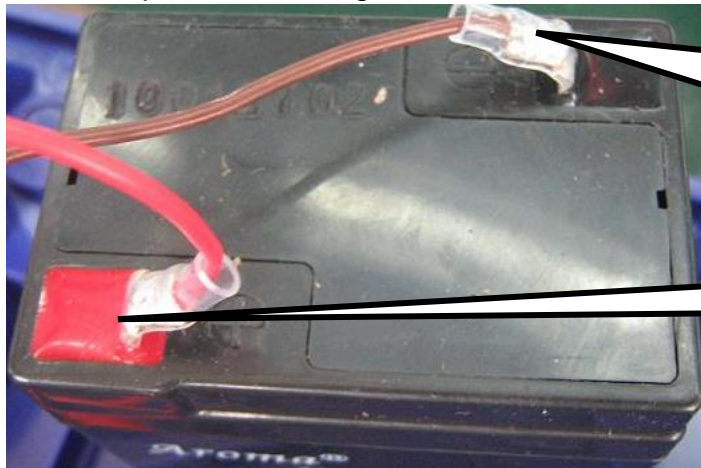

Brown cable(or black cable) connected with Anode of battery

Red cable connected with Cathode of battery

Safety Warnings

1. The electrolyte of battery is caustic which causes metal, cotton, etc to corrode.
2. The hydrogen will be resolved when using or charging the battery and it will cause explosion when approaches fire.



No Burning



Caution Corrosion



Warning Explosion



Children Faraway

Chapter 1 Introduction



1-1 Production Introduction

1. High performance A/D converter
 - 0.3 uv/D high sensitivity
 - zero point adjustable range -2mV~ +5mV
 - Sampling speed 15 times/second
 - use range -4mV ~ +30mV
 - non-linear scale 0.01% full scale
 - load cell stimulate power source 5V DC ±2% 100mA
2. According to different resolution to do linearity calibration
 - Ordinary resolution models (below 10000)
Do specification calibration first then do weight calibration
 - High resolution models (10000~30000)
Do linearity calibration first → specification calibration → weight calibration at last
3. LCD display with LED backlight, powered by battery or plug-in mains, automatic power-off function to ensure the stability of the scale. When battery voltage is lower than the system voltage, scale is automatically powered off to ensure the accuracy and stability of the scale.
4. Check Weighing function for high limit and low limit and OK range.
5. 5 HOLD functions including animal scale HOLD
6. Depending on actual space, a RS232 card and/or a relay card can be installed.

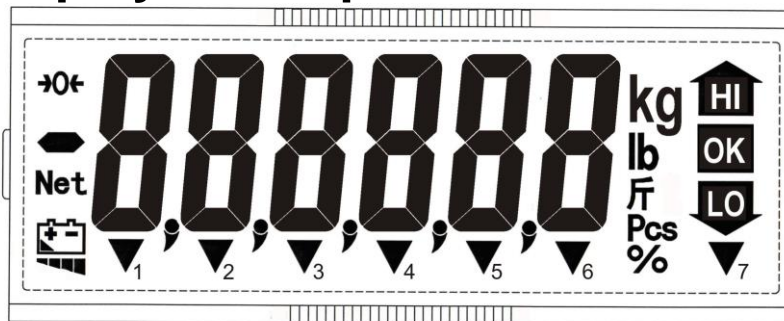
1-2 Display Description



HI	:	High limit value
OK	:	OK range within HI and LO limits
LO	:	Low limit value
kg	:	"kg" unit
lb	:	"lb" unit
Pcs	:	Counting mode
%	:	Percent indication
→0←	:	"Zero" indication
Net	:	"Net weight" indication
	:	"Low battery power" indication

▼1	:	"Stable" indication
▼2	:	"Pre-tare mode" indication
▼3	:	(M+) "Accumulation mode" indication
▼5	:	() "Samples insufficient" indication
▼6	:	() "Unit weight insufficient" indication
▼7	:	"Viss" unit (Burma unit)

 For Dual Range Models, the indicator 5 and 6 will be defined as below:

▼6 is Range 1 ▼5 is Range 2

1-3 Keypad Functions Description

5 key (4 key model does not have **UNITS** key)

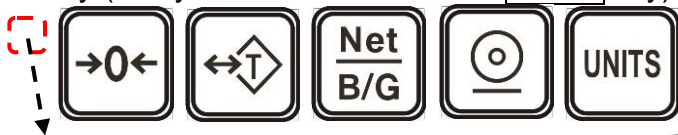

Hidden backlight key at upper left corner

10 key

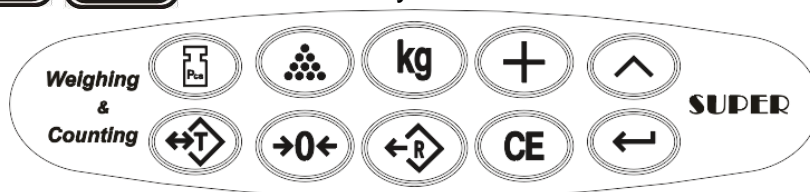

12 key

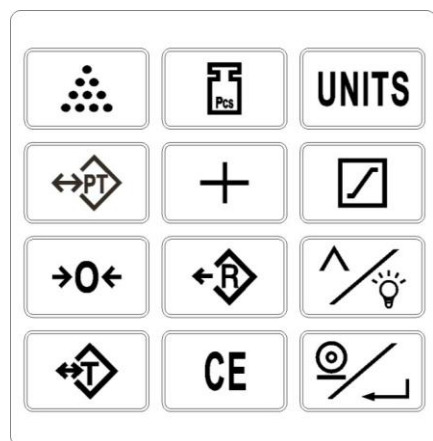

Key description	4/5 key	10 key	12 key	Other variation
Net/Gross key				NET/GROSS
Loop select from the preset units	UNITS	UNITS	UNITS	lb/kg
Preset weight and quantity for weight check or quantity check				TGT SET
Accumulate weight or quantity		+	M+	
Tare to deduct the container weight				TARE
Set preset tare				
Recall the totalization value, preset value and pre-tare value				RE-CALL
Clear the totalization value, preset value and pre-tare value.		CE	CE	
Zero the scale.	0	0	0	ZERO
Press this key to input the numbers (0 ~ 9) and to light up the backlight.		^		
Press this key to print the total data and to confirm				PRINT
Go into counting mode				COUNT or Q'TY SET
Press this key to sample				SMPL

key and key are not available for 10-key models.

1-4 Power Description

Power	Battery	6V 4Ah Rechargeable battery
	Plugged in	110V / 220V AC
Power consumption with 1X350Ω load cell	No backlight	26 mA
	Single display with backlight	32 mA
	Dual display with backlight	40 mA

Low Power Alarm

Please note when the () symbol keeps flashing on the left down corner of the display, the batteries should be recharged.

 When the low battery warning symbol shows up, scale is turned off automatically after 5~10 hours if it is used without backlight (1~2 hours if it is used with backlight). Then scale must be fully recharged, before operating again.

 Please recharge at once when the symbol  shows in order to keep the weight accuracy.

1-5 Error Messages

oL ⇒ Weight exceeds 9d of maximum capacity. (d=division)

E1 ⇒ Zero value after power on is over +10% FS.

E2 ⇒ Zero value after power on is less than -10% FS.

E4 ⇒ Unstable zero return, unstable over 10 sec. Press  to leave E4.

E6 ⇒ Zero is too high when calibrating. (over internal value 350,000)

E7 ⇒ Zero is too low when calibrating. (under internal value 80,000)

E10 ⇒ The scale is not in level status.(only available with level detector equipment.)

----- ⇒ For weight < -20d without tare or pretare device in operation.

E10 Level Switch (option)

Make JP102 on PCB board of AW, HW, FD, RW, TW) to be open circuited. Then connect signal to CN101 on PCB of AW, HW, FD, RW, TW). When CN101 is open circuited, display shows E10 after 2 seconds and all keys stop working in the mean time. When CN101 is short circuited, display resumes and can continue weighing. If you do not need level switch, make JP102 short circuited.

Chapter 2 General Operation Description

2-1 Backlight Function

Press  key to select the display backlight mode:

bL. Auto ⇒ “Auto Backlight” mode. When the weight is over 10d or any key is pressed, the display backlight will be switched on. When the weight returns to zero (the weight on platform is less than 10d), the display backlight will switch off after 10 seconds.

bL. On ⇒ Display backlight is on all the time.



bL. oFF ⇒ Display backlight is off.

2-2 Weighing Mode

2-2-1 Units Selection (not available in 4 key model)





1. After indicator is turned on, use  key to select a unit from kg, lb, tael or viss, as the screen indicated.
2. The selected unit will be memorized when you turn the indicator off. And the memorized unit will appear after you turn on the indicator next time.



2-2-2 Zero Function

Press  key to re-zero the display with no load on the platter. When zero is set, the () symbol will be displayed.

2-2-3 Tare Function







1. When the weight of the container is unknown ()

- ① Place the container on the platter, after stable and press  key, the weight value returns to zero and net indication (**Net**) is on.
- ② Place goods into the container, then the indicator shows the net weight of goods.
- ③ Clear tare value
When removing the container and goods, the display shows the negative weight value of the container. Then press  key to clear tare value. The indicator returns to zero and net indication (**Net**) is on.
- ④ Recall tare value
Press  then  key ⇒ the display shows tare value

 Multiple tare operation ⇒ Users can continuously increase or decrease the tare value by pressing the  key.



 The total tare value (tare value + pre-set tare value) can equal the full capacity of the indicator.

2. When the weight of the container is known ()

- ① Press  key and the display shows $\geq \square \leq - . - . - \square$.
Use  and  keys to input weight value of the container. After finishing the procedures, the net indication (**Net**) and pretare (PT) indication “▼” is on.
- ② Place goods into the container, then the indicator shows the net weight of goods.
- ③ Clear pretare value
Press  then  key, and then press  key to clear pretare value.
When indicator returns to zero, net indication (**Net**) and pretare (PT) indication “▼” are

off.





④ Recall pretare value

Press  then  key ⇒ the display shows pretare value

 In Tare mode, the Preset tare function is disabled.

 The indicators with two weighing ranges can NOT pre-set the tare value larger than the first weighing range. For example: a 30 kg indicator is set by two weighing ranges. The first range is 0 to 15 kg, and the second range is 15 to 30 kg. The pre-set tare value can not be larger than 15 kg.

2-2-4 Net/Gross Function (only available in 4/5 key models)

In Tare mode, press  key once to display gross value. Net symbol “▼” disappears, and the gross value “▼” appears. Press  key again, it displays net value, net symbol “▼” appears and gross symbol “▼” disappears. Press  key continually to display net value or gross value. In tare mode,  key is able to work. When it displays “▼”, all keys are disable except







2-2-5 Check Weighing Mode (4/5 key models need to set through F4)

1. Preset “High limit”, “Low limit” and “Beeper value” operation

Use  and  key to preset values.

For example:





Preset “Low limit” (Low limit > 10d) e.g. *Low limit = 20 kg*

Press  key	the display shows	≥ 0 ≤ - - . - - L
Press  key 1 time	the display shows	0 ≥ 0 ≤ - . - - L
Press  key 2 times	the display shows	0 ≥ 2 ≤ - . - - L
Press  key 4 times	the display shows	0 2 0.00 ≥ 0 ≤

Preset “High limit” (High limit ≥ Low limit) e.g. *High limit = 25 kg*

Press  key 1 time	the display shows	≥ 0 ≤ - - . - - H
Press  key 1 time	the display shows	0 ≥ 0 ≤ - . - - H
Press  key 2 times	the display shows	0 ≥ 2 ≤ - . - - H
Press  key 1 time	the display shows	0 2 ≥ 0 ≤ . - - H
Press  key 5 times	the display shows	0 2 ≥ 5 ≤ . - - H
Press  key 3 times	the display shows	0 2 5.00 ≥ 0 ≤

Preset “Beeper value” (Refer to **Note**) e.g. *Beeper value = 22*

Press  key 1 time	the display shows	≥ 0 ≤ - b
Press  key 2 times	the display shows	≥ 2 ≤ - b
Press  key 1 time	the display shows	2 ≥ 0 ≤ b
Press  key 2 times	the display shows	2 ≥ 2 ≤ b
Press  key 1 times	the display shows	0.000

☰ Preset Single point (preset low limit only):

After “preset low limit” procedures is completed and the display shows $\geq 0 \leq - - . - - H$, then press  key again, the display shows 0.000. This means that the “preset single point” procedure is completed.

NOTE

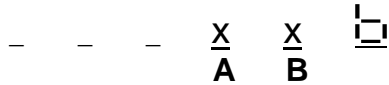

- A** Setting for the status that LCD is on and the beeper beep:
 - 0 = when stable, the beeper beeps and LCD is on.
 - 1 = when stable, the beeper beeps; whether stable or not, LCD is on.
 - 2 = whether stable or not, the beeper beeps and LCD is on.
 - 3 = open warning device: when the weight is higher than HI value and the weight is stable, LCD is on and Relay Card open.
- B** Setting for the beep status:
 - 0 = No beep
 - 1 = OK (when the weight is over Low Limit & under or equal to High Limit.), the beeper beeps.
 - 2 = When the weight is under or equal to Low Limit & over High Limit, the beeper beeps.

☰ Under Status in Preset Low Limit (preset single point only)

The BEEP, LCD mode should be fixed as follows:

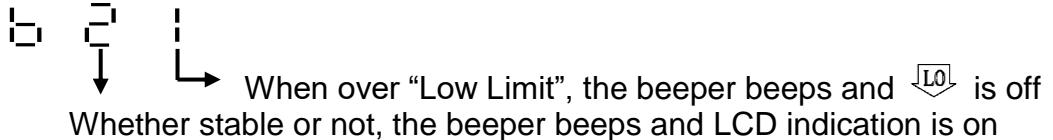

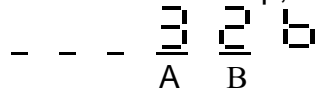

☰ Warning device setting (not available in 4/5 key models)

Set HI value and value of the beep, LCD mode should be fixed as follows:





When the weight equals to HI value, Relay Card open and the weight is accumulated. Press  key to dismiss the warning sound and the range of accumulated weight is [000.000]~[999999].

☰ Clear warning accumulation (not available in 4/5 key models)



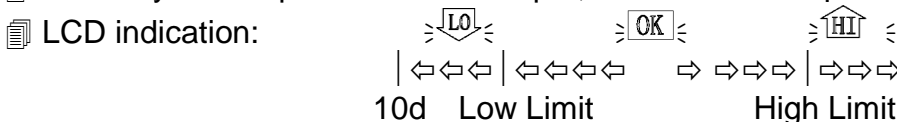

- ◆ Press  key first and then press  key to clear all accumulated data.
- ◆ Accumulated data is cleared automatically under following conditions
 - a. when shift among weight mode, counting mode and warning accumulation mode.
 - b. when shift the units
 - c. turn off the scale

☰ Set relay low output: L1 => low output; L0=> no low output









◆ To exit preset mode, please press  key.

2. Recall Check-weighing Values (not available in 4/5/10 key models)

- Press  key then press  key => Recall “Low limit value”
- Then press  key again => Recall “High limit value”
- Then press  key again => Recall “Beeper value”
- Then press  key again => Back to the beginning





3. Clearing Check-weighing Values (not available in 4/5/10 key models)

Press  key then press  key, and then press  key ⇒ Recall “Low limit value”. Then press  key again ⇒ Clear “High limit value” and “Beeper value”
Press  key then press  key 6 times continuously ⇒ Clear all values.



2-2-6 Totalizing (not available in 4/5 key models)

1. Weight Totalizing

Place goods on the platter, after stable and press  key to save the weight value. Then the display shows the total number of additions and the totalized weight value. And the (M+) indication “▼” will flash on the display. The indicator will recover to show the weight value of the goods on the platter after 3 seconds and the (M+) indication “▼” is on.

-  The indicator allows the next totalizing operation, even when the weight value does not return back to zero. The  key is functional, when the weight value changes by more than 10d. The indicator will save the totalized weight value after the weight is stable.
-  The indicator can totalize positive or negative weight but can't do both at the same time. The totalized weight store must be reset to zero before it is possible to select positive or negative totalizing mode.
-  The totalizing function can be used up to a maximum of 9999 times before it must be reset. The totalizing display is limited to 6 digits maximum.
-  When totalizing, RS-232 will also output. (Refer to F5 setting)

2. Clear Totalized Weight Values (not available in 4/5 key models)

- ◆ Press  then  key to clear all totalized weight values.
- ◆ When changing between weighing and counting mode, or selecting weighing unit, the indicator will automatically clear all the totalized weight values.
- ◆ The indicators will automatically clear all the totalized weight values after turning on.





3. Recall Totalized Weight Values (not available in 4/5 key models)



Press  key to display the total number of additions and the totalized weight value. And the (M+) indication “▼” will flash on the display. The indicator will return to the weighing mode after 3 seconds.

-  The indicator will not display the negative sign “-” for negative totalized weight values when recalling a totalized weight value, but when printing, the negative sign “-” will be printed out (transmitted serially) for each negative weight and negative totalized weight.

2-3 Counting Function (not available in 4/5 key models)

2-3-1 Sampling

- ❶ Press  key to select sample quantity from 10, 20, 50,100
- ❷ Select sample quantity and then place samples on the platter, and then press  key, the display shows “SAMPLE”.
After stable, the scale enters into counting mode and the display shows sample quantity.
 - ◆ Sample Too Small () ⇒ Sample is less than 20 divisions.
 - ◆ Unit Weight Too Small () ⇒ Unit weight is less than 0.2 division.
(0.1 d for Brazil regulation)

-  When sampling, the above two symbols indications are on. Under such conditions, the scale can still work, but may result in lower count precision.
-  When using 2-segment weighing mode, the above two symbol indications change to

Range 2 and Range 1 and the two symbol indications are off.

2-3-2 Check Weighing

Refer to the operation of check weighing in weighing function.

2-3-3 Totalizing

Refer to the operation of totalizing in weighing function.

Chapter 3 General Function Setting

- Switch on the scale. While the scale is counting down to zero, press and hold **→0←** key until the display shows the software version number 02018. Release the **→0←** key, the scale enters into the configuration setting mode and display F0.

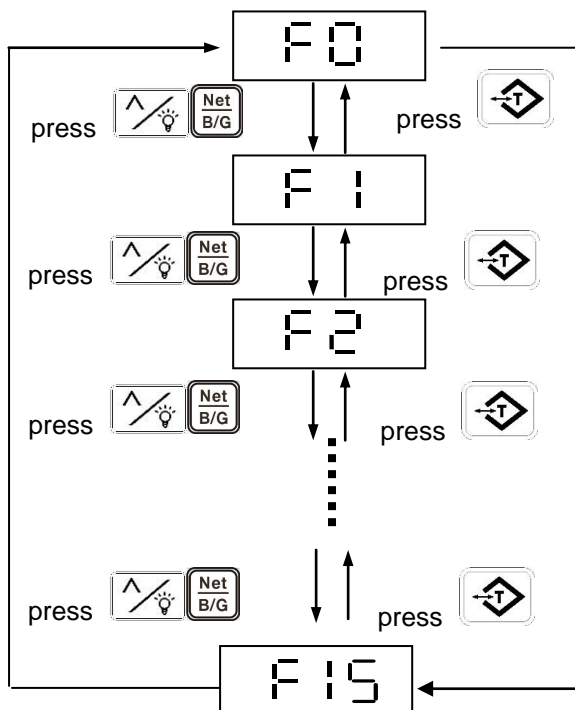

F4	Check Weighing Configurations
F5	RS232 Output Setting (Option)
F6	Exit Function
F7	Internal Value Display Mode
F8	Weight Hold Mode Setting
F11	ID Code Setting
F12	Print Key Function Setting
F14	Customized Header Setting (r n P 6, r n P 7)

F0~F3, F9, F10, F13, F15 are reserved.

key ⇒ upward key

key ⇒ downward key

key ⇒ to confirm

3-1 F4 Check Weighing Configurations

◆ If hold mode (F4) is set, accessing to F4 is denied.

Press or key to select F4

F4

Press key

0- - - - L kg

Press key for 5 times to clear HI, OK, LO values

000000 kg

Press key

F4

Preset "LO value"
(LO value > 10d)

Press and key to set "LO value"

E.g. LO value = 2 kg

002000 kg

Press key

0- - - - H kg

Preset "HI value"

(HI value ≥ LO value)

Press and key to set "HI value"

E.g. HI value = 2.5 kg

002500 kg

Press key

0- b kg

Preset "Beeper value"

Press and key to set "Beeper value"

E.g. Beeper value = 22

22b kg

Press key

L 1

Press key

F4

key = Increase the flash value by one (from 0 to 9)

key = Confirm key

- - - X X b
 A B

A ⇒ 0 = After stable, the beeper beeps and the indications are on
 1 = After stable, the beeper beeps; whether stable or not, the indications are on.
 2 = whether stable or not, the beeper beeps and the indications are on.
 3 = open warning device: when the weight is higher than HI value and the weight is stable, LCD is on and Relay Card open.

B ⇒ 0 = No beep
 1 = OK (when the weight is between Low limit & High limit.), the beeper beeps.
 2 = When the weight is under or equal to Low limit (must be over 10d) & over or equal to High limit, the beeper beeps.

◆ LCD indication description:

≧ ≧ ≧
 |←←←|←←←← →→→→|→→→→
 10d Low limit value High limit value



Relay low output setting: Use and to set 0~1; Default setting: 0. L 1 ⇒ relay low output, L 0 ⇒ relay low no output.



3-2 F5 RS-232 Output Setting (Option)

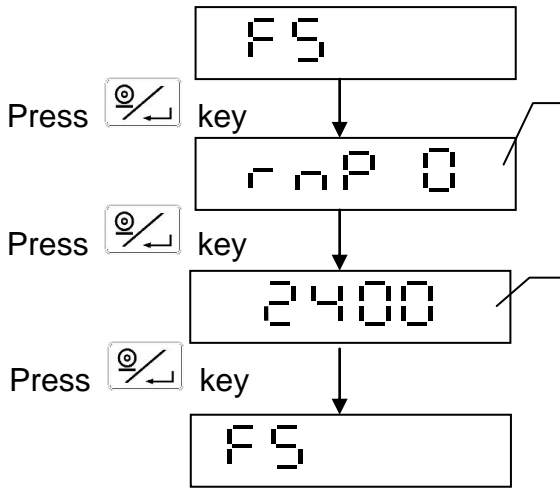



◆ Make J1、J3 on RS232 short circuit, when connecting to computer.

Use   or  key to select F5.



Transmission mode : use   key to select r n P 0 ~ r n P 14 and press  to save

RS-232 baud rate : use   key to select 1200~9600 and press  to save

- r n P 0 ⇒ RS232 command mode.
- r n P 1 ⇒ Stable transmission.
- r n P 2 ⇒ Continuous transmission.
- r n P 3 ⇒ Press  key to transmit totalized simple format.
- r n P 4 ⇒ Press  key to transmit totalized complete format.
- r n P 5 ⇒ Stable transmission in totalizing mode. Same format as (r n P 3).
- r n P 6 ⇒ Press  key to transmit simple free format. Please refer to F14.
- r n P 7 ⇒ Press  key to transmit complete Free format. Please refer to F14.
- r n P 8 ⇒ While use Hold, press  key to transmit same format as (r n P 1) and (r n P 2).
- r n P 11 ⇒ Print after removing goods (5% mode).
- r n P 12 ⇒ Print after removing goods (OK mode).
- r n P 13 ⇒ MODBUS function, need to use with F11 ID Code Setting
- r n P 14 ⇒ Stable transmission, only weight value is transmitted
- r n P 15 ⇒ Enter serial number, reply serial number, weight
- r n P 16 ⇒ Continuous transmission with High, Low, Ok status

RS-232 Interface Format

I . Mode: UART Signal of EIA-RS0232 C

II . Format :

1. Baud rate : 1 200, 2 400, 4 800, 9 600 bits/second
2. Data bits : 8 bits
3. Parity bit : None
4. Stop bits : 1 bit
5. Code : ASCII (Exchange code of American standard)





RS-232 Data Format
Command mode (r n P 0)

Command	Function	Return message definition
C T <CR> <LF>	Clear tare	N P <CR> <LF> already pre-tared C T <CR> <LF> successful
M T <CR> <LF>	Tare	N P <CR> <LF> already pre-tared M T <CR> <LF> successful N S <CR> <LF> unstable
M Z <CR> <LF>	Zero	N P <CR> <LF> already pre-tared N T <CR> <LF> already tared M Z <CR> <LF> successful N Z <CR> <LF> outside zero range N S <CR> <LF> unstable
R W <CR> <LF>	Read Weight	Return weight format as (r n p1)
P T , 0 0 0 1 0 0 <CR> <LF>	Set pre-tare	N O <CR> <LF> exceed number of digits
L O , 0 0 0 1 0 0 <CR> <LF>	Set low limit	N N <CR> <LF> non-numeric value
H I , 0 0 0 1 0 0 <CR> <LF>	Set high limit	N G <CR> <LF> over max weight
		N D <CR> <LF> Increment d is incorrect
1 1 b <CR> <LF>	Set buzzer	1 1 b <CR> <LF> successful

Stable transmission (r n P 1), Continuous (r n P 2), Press  key to transmit (r n P 8)

1. gram as weight unit

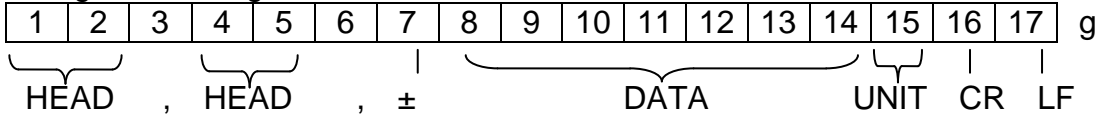

2. kg or lb as weight unit

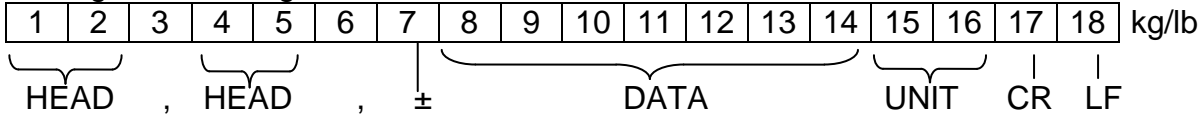

HEAD1 (2 BYTES)	HEAD2 (2 BYTES)
OL - Overload , Under load	TR - TARE Mode
ST - Display is Stable	NT - NET Mode
US - Display is Unstable	GS - GROSS Mode

DATA (7 or 8 BYTE)

2B (HEX) = “ + ” (PLUS)

2D (HEX) = “ - ” (MINUS)

2E (HEX) = “ . ” (DECIMAL POINT)

UNIT (2 、 3 or 4 BYTE)

kg = 6B (HEX) ; 67 (HEX)

lb = 6C (HEX) ; 62 (HEX)

tl.T = 74 (HEX) ; 6C (HEX) ; 2E (HEX) ; 54 (HEX)

hkg = 68 (HEX) ; 67 (HEX)

viss = 76 (HEX) ; 69 (HEX) ; 73 (HEX) ; 73 (HEX)

Transmission examples: (r n P 2) RS-232 continuous transmission



1. The gross weight (+0.876 kg) shows as below, after stable: (no tare or pre-tare mode)

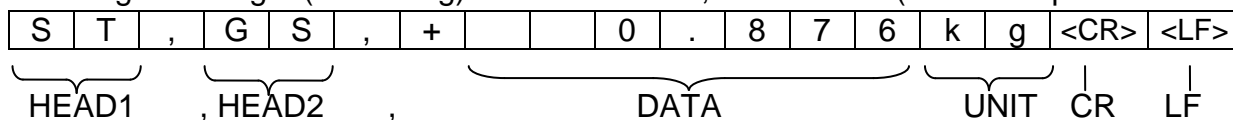

2. The net weight (-1.568 lb) shows as below without weight stability: (under tare or pre-tare mode)

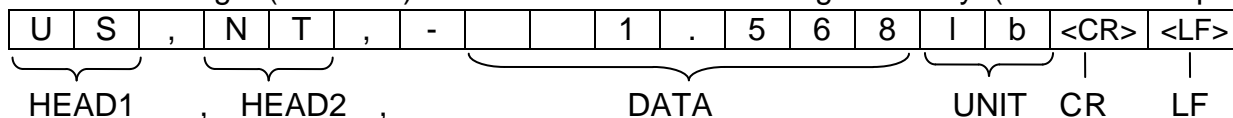

Press key to transmit totalized simple format (r n P 3)

S/N	WT/UNIT (kg / lb)
0001	1.0000
0002	1.0000
0003	1.0000
0004	1.0000
0005	1.0000
0005	5.0000

➔ Press or **M+** key

➔ Press or **M+** key

➔ Press or **M+** key

➔ Press or **M+** key

➔ Press or **M+** key

➔ Press twice to print TOTAL

Press key to transmit totalized complete format (r n P 4)

TICKETS NO. 0001

G 1.000kg

T 0.000kg

N 1.000kg

(3 blank lines)

➔ Press or **M+** key

TICKETS NO. 0002

G 1.000kg

T 0.000kg

N 1.000kg

(3 blank lines)

➔ Press or **M+** key

TICKETS NO. 0003

G 1.000kg

T 0.000kg

N 1.000kg

(3 blank lines)

➔ Press or **M+** key

TOTAL NUMBER OF TICKETS 0003

TOTAL

NET 3.000kg

(3 blank lines)

➔ Press twice to print TOTAL

G = GROSS T = TARE N = NET

**Stable Transmission in totalizing mode (r n P 5)**

S/N	WT/UNIT (kg / lb)	
0001	1.0000	☞ The scale is stable
0002	1.0000	☞ The scale is stable
0003	1.0000	☞ The scale is stable
0004	1.0000	☞ The scale is stable
0005	1.0000	☞ The scale is stable

0005	5.0000	☞ Press  twice to print TOTAL

Press  key to transmit simple free format (r n P 6)

Same format as (r n P 3). Print the complete format for the first time. Then only print NET weight. Please refer to F14 for details.

Press  key to transmit complete free format (r n P 7)

Same format as (r n P 4). Print the complete format all the time. Please refer to F14 for details.

While use Hold, press  key to transmit (r n P 8)

If there is only RS-232, press  to print out the HOLD value on the display in HOLD MODE.

Print after Removing Goods (5% mode) (r n P 11)

Stage	Condition(s)	Action(s)
1: Goods placed and weighed on platter	Weight has become stable. Weight > zero point Weight ≥ 20 weighing units (i.e. 5% x Weight ≥ 1 weighing unit)	Beeper beeps twice, and printing data (stable weight compliant with conditions on the left) is ready to be sent.
2: Just removed goods from platter	Instantaneous weight reading drops below 95% of last stable weight (stable weight of Stage 1)	Printing data of Stage 1 is sent to the printer (same printing formats as those of (r n P 1).

Print after Removing Goods (OK mode) (r n P 12)

Stage	Condition(s)	Action(s)
1: Goods placed and weighed on platter	Weight has become stable. Weight > zero point Check weighing OK status (within a predetermined weight range)	Beeper beeps twice, and printing data (stable weight compliant with conditions on the left) is ready to be sent.
2: Just removed goods from platter	Instantaneous weight reading drops below 95% of last stable weight (stable weight of Stage 1).	Printing data of Stage 1 is sent to the printer (same printing formats as those of (r n P 1).

r n P 13 ⇒ MODBUS Function, Use with F11 ID Code Setting

Formats as in r n P 1 (stable), r n P 2 (continuous), r n P 8 (key), please refer to F11 for details.



Stable Transmission Only Weight Value Is Transmitted (r n P 14)

No +/- . If display is 1.000kg , transmit

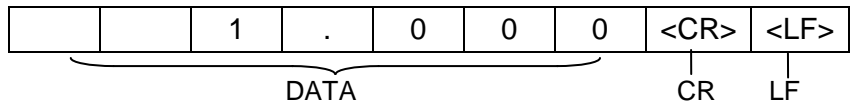

r n P 15 ⇒ Enter Serial number, Reply Serial Number and Weight

Enter the serial number (up to 64 characters), if you enter the SN number: SN0001<CR><LF>, if it displays 1.000kg, etc. After stable, RS232 output format: SN0001,001.000kg<CR><LF>

r n P 16 ⇒ Continuous Output Contains High, Low, Ok Status

The continuous output format is similar to r n p 2, the first code of HEAD2 is gross/net weight, and the second code output includes High(H), Low(L), Ok(O) states, if Low is set to 0.500kg and High is set to 1.000kg, then 0.876 kg output is as follows.

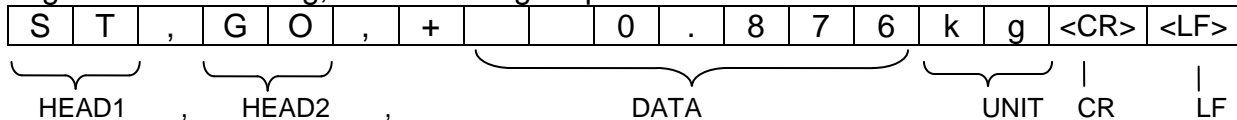

F5	Function	Press key	Press key	Press key twice after zeroing
r n p 0	RS232 command mode	Once received read weight command, transmit weight in same format as r n p 1.		
r n p 1	Stable transmission	After return to zero, transmit next stable weight.		
r n p 2	Continuous transmission.	RS232 transmit continuously. Keypad has no effect.		
r n p 3	Press key to transmit totalized simple format	Transmit when weight change >±10d,	Transmit when weight change >±10d,	Print TOTAL and clears totalized values
r n p 4	Press key to transmit totalized complete format.	Transmit when weight change >±10d,	Transmit when weight change >±10d,	Print TOTAL and clears totalized values
r n p 5	Stable transmission in totalizing mode (After return to zero, transmit next stable weight which is > +10d)	No transmission	No transmission	Print TOTAL and clears totalized values
r n p 6	Press key to transmit simple free format	Transmit when weight change >±10d,	Transmit when weight change >±10d,	Print TOTAL and clears totalized values
r n p 7	Press key to transmit complete free format	Transmit when weight change >±10d,	Transmit when weight change >±10d,	Print TOTAL and clears totalized values
r n p 8	While use Hold, press key to transmit same format as (r n P 1) and (r n P 2)	No transmission	Transmit as stable weight >±10d	No transmission, totalized values not cleared
r n p 9	Continuous Transmission (Brazil)	Continuous transmission	Continuous transmission	Continuous transmission, totalized values not cleared
r n p 10	or key Transmission (Brazil)	RS232 transmit	RS232 transmit	Print TOTAL and clears totalized values
r n p 11	Print after removing goods (5% mode)	After placing item and become stable, beep twice. RS232 transmit item weight after item is removed.		

F5	Function	Press key	Press key	Press key twice after zeroing
r n p 12	Print after removing goods (OK mode)	RS232 transmit only "OK" item weight after item is removed. No transmission while in "HI" or "LO".		
r n p 13	MODBUS Function	Use MODBUS to transmit weight, and need to use with F11 ID Code Setting,		
r n p 14	Stable transmission, only weight value is transmitted	After return to zero, transmit next stable weight's weight value only.		
r n p 15	Enter serial number, reply serial number, weight	Enter serial number and put the weight on. Once it is stable, return serial number and weight		
r n p 16	Continuous Output Contains High, Low, Ok Status	RS232 transmit continuously containing High, Low, Ok Status. Keypad has no effect.		

<CR>=ASCII carriage return character, hexadecimal is 0D.

<LF>=ASCII line feed character, hexadecimal is 0A.

3-3 F6 Exit Function

Use or to select F6. Then press to count down to zero and exit the setting.

3-4 F7 Internal Value Display Mode

Use or to select F7. Then press to display internal value. Press again will see F7.

3-5 F8 Weight Hold Mode Setting

Use key or key choose F8

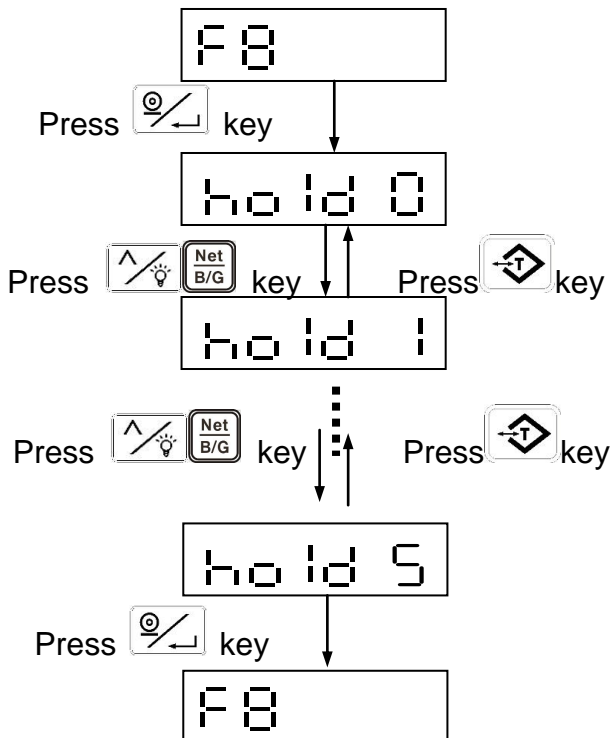



- ◆ Before setup, please switch the SWA1 on MINI JUMPER to ADJ position
- ◆ After setup, please switch the SWA1 on MINI JUMPER back to LOCK position

In hold mode, press key, to print the hold value as shown on display.

(It's not related to the settings of F5 transmission mode, but it needs to select the proper Baud rate according to the transmission of the receiver.)

(To setup transmission rate, please refer to F5 RS-232 Interface Output Setting (option))

Use key to select a value from hold 0 ~ hold 5 and then press key to complete setup.

- hold 0 = No hold function
- hold 1 = For varying weighing value, the scale will automatically hold the maximum weighing value to display. To exit hold mode, press any key (except the  key).
- hold 2 = After the scale is stabilized, the scale will automatically hold the display value(not changeable due to external variables)To exit hold mode, press any key.(except the  key)
- hold 3 = After the scale is stabilized, the scale will automatically hold the display value(not changeable due to external variables).After zero return (or weight is less than 10d), the scale exits the hold mode automatically.
- hold 4 = Animal Scale function. When animal is on the scale platter and is stable, the scale will automatically hold the display value (not changeable due to external variables). After the animal is off the scale platter, the scale exits the hold mode automatically.
- hold 5 = Animal Scale hold function 2. Initially scale displays “0.000” on empty load. When animal is on the scale platter and is stable, the scale will automatically hold and lock the display value (not changeable due to external variables). When weight change (increment or decrement) exceeds the defined “weight hold range”, the scale exits the hold mode and recalculates weight. If weight is unstable, the average weight value will be displayed and held for 10 seconds.

Animal Scale Hold Setup (hold 4)

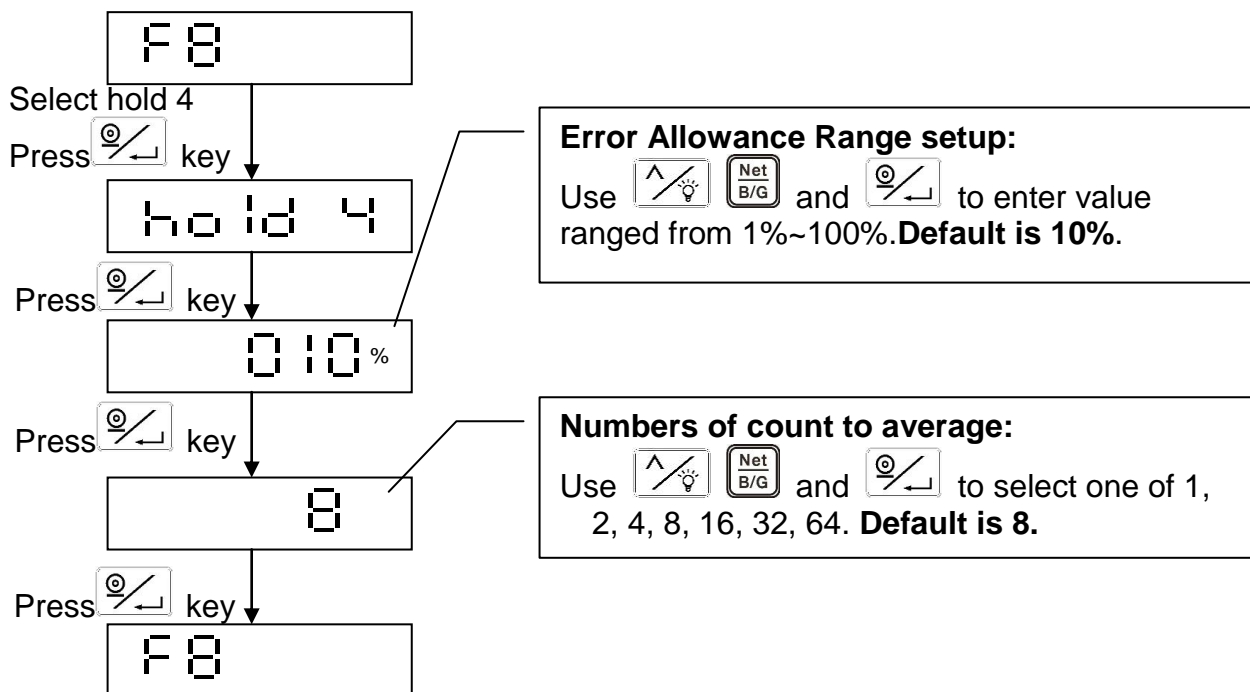

Animal Scale Hold Function 2 (hold 5)

-  How to activate **hold 5** – “Brazilian” Animal Scale Hold Function:
1. Select **HOLD 5** in **F8** menu. Set the Weight Hold Range (during weight hold, when weight deviation [positive or negative] exceeds Weight Hold Range, the scale exits the hold mode).
 2. Display returns to weighing mode. Place an animal (pig, dog, cow, etc.) on the scale. After the buzzer beeps, weight hold is complete.
 3. Now you can try adding additional weight within Weight Hold Range to test if the weight still holds correctly. Or you can remove all weight(s) to verify that the hold mode exits automatically.



- Repeat above Steps 2-3 to make 10 or more measurements, then compare deviations among these 10 measurements.

How to exit hold mode:

Suppose Weight Hold Range is set as 1.000 kg, and the weight held after stable is 8.543 kg (now the weight is held with buzzer already beeped, weight value will not change), when weight change (increment or decrement) equals or exceeds Weight Hold Range (i.e. $8.543\text{kg} + 1.000\text{kg}$ or $8.543\text{kg} - 1.000\text{kg}$), scale will automatically exit hold mode, then scale will recalculate holding weight (i.e. changing weight is displayed in real time until weight becomes stable, and scale enters hold mode). This whole hold mode entry and exit process will repeat continuously.



3-6 F11 ID Code Setting

(must be used with r n P 1, r n P 2, r n P 8 of F5)

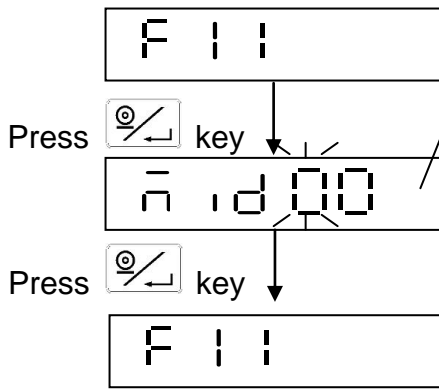
Press   key or  key to select F11



Machine ID code setting:

Use   and  to set 01 ~ 99. Default setting: 00
 (1) "00": RS-232 does not transmit Machine ID.
 (2) "01~99": RS-232 transmits Machine ID.

RS232 DATA FORMAT

Stable transmission (r n P 1), Continuous (r n P 2), Press  key to transmit (r n P 8)

- e.g. Machine ID code is 10.

The gross weight (+0.876 kg) shows as below, after stable: (no tare or pre-tare mode)



1	0	S	T	,	G	S	,	+	0	0	0	.	8	7	6	k	g	<CR>	<LF>
ID			HEAD1		HEAD2		DATA										UNIT		

- e.g. Machine ID code is 00. (Not using Machine ID function.)

The net weight (-1.568 lb) shows as below without weight stability: (under tare or pre-tare mode)

U	S	,	N	T	,	-	0	0	1	.	5	6	8	l	b	<CR>	<LF>
HEAD1			HEAD2		DATA										UNIT		

3-7 F12 Print Key () Function Setting

Press   key or  key to select F12

F 12



Press  key

P r F 0

Press  key

F 12

Print key setting:

Use   and  to set 0~2. Default setting: 0

P r F 0 ⇒ If weight variation is beyond $\pm 1d \sim \pm 10d$,  key print totalized weight. Otherwise print current weight. (d=division)

P r F 1 ⇒  key print current weight. No totalization.

P r F 2 ⇒  key print current weight if it is within the lower and upper limits (ok range). No totalization.



3-8 F14 Customized Header Setting (r n P 6, r n P 7)

CODE	Description	CODE	Description
0	No print.	5	N
1	TICKET NO.	6	P/N
2	G	7	S/N
3	T	8	DATE (Note: need FB530's MINI_PRINTER to print)
4	PT	9	TIME (Note: need FB530's MINI_PRINTER to print)

F14 contains a 9-digit code. For example: 6 1 2 3 4 5 0 0 0

① F5 = r n P 6 Simple Free Format

② F5 = r n P 7 Complete Free Format

P/N 012345678901
TICKET NO. 0001
G 1.2500kg
T 0.2500kg
PT 0.0000kg
N 1.0000kg
S/N WT/UNIT (kg)

0001 1.0000
0002 1.0000

0002 2.0000

→ Press or Press key
→ Press or Press key
→ Press twice to print the total

P/N 012345678901
TICKET NO. 0001
G 1.2500kg
T 0.2500kg
PT 0.0000kg
N 1.0000kg
(three empty lines)

P/N 012345678901
TICKET NO. 0002
G 1.2500kg
T 0.2500kg
PT 0.0000kg
N 1.0000kg
(three empty lines)

TOTAL NUMBER
OF TICKETS 0002
TOTAL
NET 2.0000kg

P/N (part No.) and S/N (Serial No.) setup method
In weighing mode, hold key for 2 seconds to setup.



1 second ⇒

0	0	0	0	0	0
▼					
0	0	0	0	0	0
▼					
0	0	0	0	0	0
▼					
0	0	0	0		
▼					

Use , key to enter 12-digit Part number



1 second ⇒

0	0	0	0	0	0
▼					
0	0	0	0		
▼					

Use , key to enter 10-digit Serial number

📄 After power-off, S/N will reset as 1. P/N will be saved in memory, available during next power-on.

Appendix 1 Option Card Description

RS232 Output

1. Weighing scale (AW, HW, FD, RW, TW)

RS232 card's 6PIN cable connect to CN3 of mainboard

SCALE	→	RS232 PRINTER	SCALE	→	PC
DB 9 (female)		DB 9 (female)	DB 9 (female)		DB 9 (male)
2 TX	→	3 RX	2 TX	→	2 RX
3 RX	→	2 TX	3 RX	→	3 TX
5 GND	→	5 GND	5 GND	→	5 GND

 Please refer to F5 function settings for transmission mode, baud rate setting and data format.

Relay Output

Principle of Relay operation

Use checkweighing pre-set key (TW, AW) or though F4 from the menu (TW, AW, RW, HW) to get in checkweighing mode to set the HIGH and LOW limit points. Between HIGH and LOW limits are OK range.

If the weight is below LOW limit, the data will output in LOW port;

If the weight is between HIGH and LOW limits (OK range), the data will output in OK port;

If the weight is above HIGH limit, the data will output in HIGH port

 Please refer to the operation of Pre-set key and F4 function.

Weighing scale (AW, HW, FD, RW, TW)

1. PIN definition

- PIN 1 ⇒ OK output
- PIN 2 ⇒ High output
- PIN 3 ⇒ Low output
- PIN 4 ⇒ VDD
- PIN 5 ⇒ GND
- PIN 6 ⇒ COMMON

2. Connection

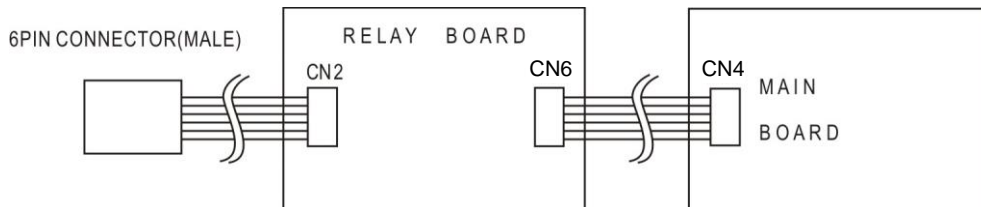

3. Power supply for Relay

The power supply for RELAY can be by an external power source or by the system itself.

- ① Externally power supply
- PIN4, PIN5 connect to external power supply
- J1, J2 OPEN

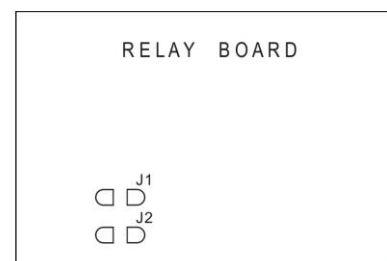

- ② Internally power supply from the system itself
Do not connect any power supply to PIN4, PIN5
J1, J2 SHORT

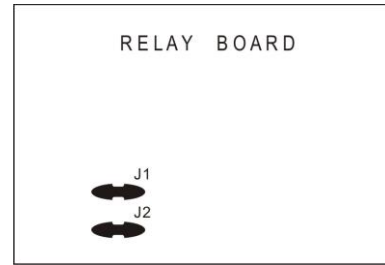

4. Configuration

OK, High, and Low can be set to NO (normally open, Type A) or NC (normally closed, Type B).
The default value is NO (normally open, Type A)

- ① OK, High, and Low are NO (normally open, Type A) ⇒ default

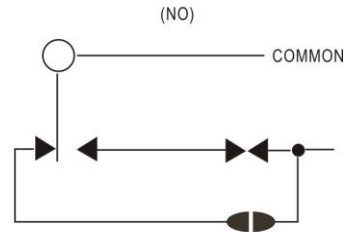
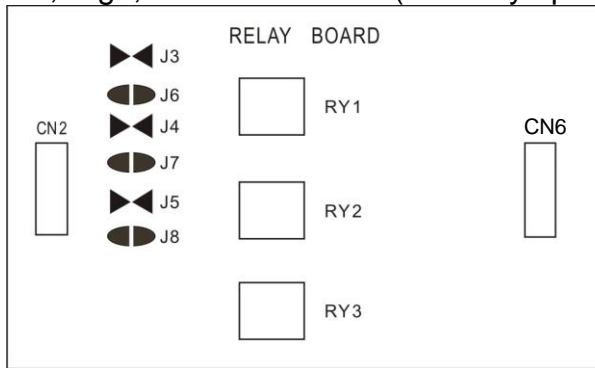

- ② OK, High, and Low are NC (normally close, Type B)
Open J3, J4, and J5 by cutting the circuit
Then short J6, J7, and J8 with solder.

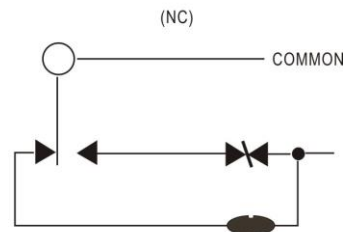
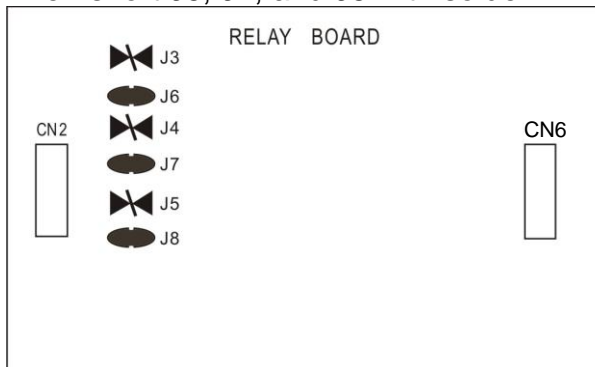

Appendix 2 Load Cell PIN

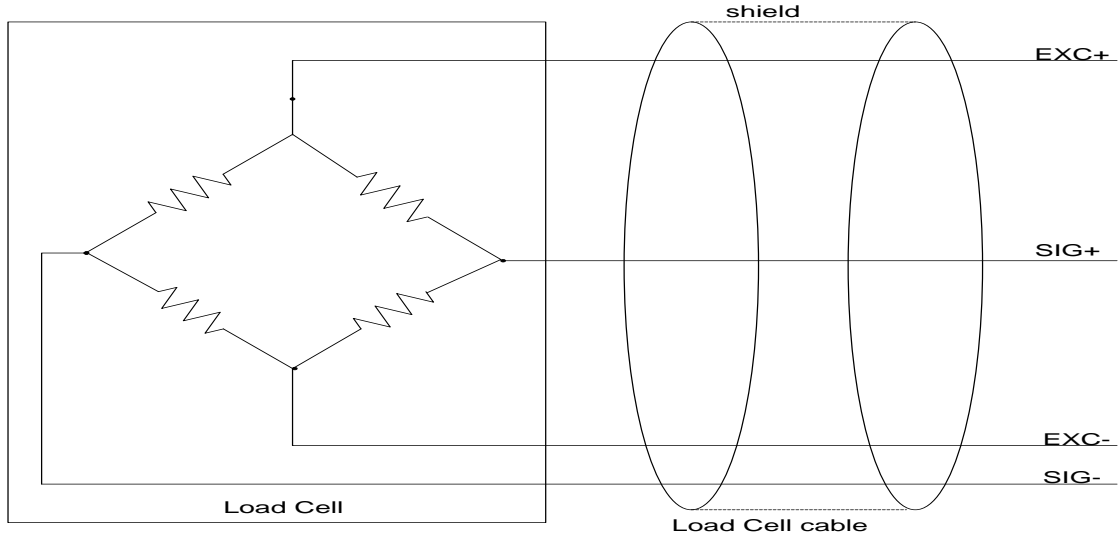

5-pin female connector

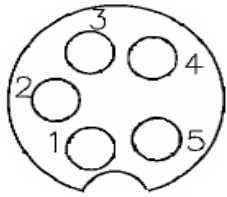

Weighing scale
(AW, HW, FD, RW, TW)

1	EXC+
2	EXC -
3	SIG+
4	SIG -
5	GND

Appendix 3 MODBUS Data Address Table

MODBUS Data Address Table I

Data Register		Bit I/O		Bit I/O	
Function Code 03 (Read)		Function Code 01 (Read)		Function Code 05 and 15 (Write)	
Modbus	SCALE	Modbus	SCALE Output	Modbus	SCALE Input
40004 ~ 40005	As display value	00000	Stable status	01000	Zero
		00001	Zero status	01001	
Function Code 06 and 16 (Write)		00002	Gross	01002	Tare
41000 ~ 41001	Pre-tare value	00003	Net	01003	Clear tare
41014 ~ 41015	LO limit value	00059	Hi		
41018 ~ 41019	HI limit value	00060	Ok		
		00061	Lo		

MODBUS Data Address Table II (For Hitech and Pro-face Human Machine Interface)

Data Register		Bit I/O		Bit I/O	
Function Code 03 (Read)		Function Code 01 (Read)		Function Code 05 and 15 (Write)	
Modbus	SCALE	Modbus	SCALE Output	Modbus	SCALE Input
40005 ~ 40006	As display value	00001	Stable status	01001	Zero
		00002	Zero status	01002	
Function Code 06 and 16 (Write)		00003	Gross	01003	Tare
41001 ~ 41002	Pre-tare value	00004	Net	01004	Clear tare
41015 ~ 41016	LO limit value	00060	Hi		
41019 ~ 41020	HI limit value	00061	Ok		
		00062	Lo		

Appendix 4 7-Segment Display Characters

0	1	2	3	4	5	6	7	8	9
A	B	C	D	E	F	G	H	I	J
K	L	M	N	O	P	Q	R	S	T
U	V	W	X	Y	Z				

